



Owner's Manual

MODELS
EAH/EC/E TALL, 3-Door
Installation and Operation
Revision 1.03



CMA DISHMACHINES
12700 KNOTT STREET
GARDEN GROVE, CALIFORNIA 92841

800-854-6417

FAX 714-895-2141

	Title	Installation & Operation	Rev 1.03
	Model	EAH / EC Dishwasher	08/24/17

TABLE OF CONTENTS

***SPECIFICATIONS*..... 3**
EAH / EC Dishmachine..... 3

***GETTING STARTED* 4**
Introduction to EAH and EC 4
Receiving and Installation 4
1. Packaging 4
2. Electrical 4
3. Plumbing 5
4. Scrap Trap Accumulator 5
5. Chemical Feeder 6
6. Activating Machine 6

***OPERATION*..... 7**
Starting Instructions..... 7
Operating Instructions 8
1. Scraping and Pre-rinse 8
2. Sorting and Racking 8
3. Racking dishes 8
4. Racking glasses 9
5. Racking flatware 9
6. Stacking & Storage 9
Cleaning and Maintenance 11
1. Cleaning the drain screen..... 11
2. Cleaning the washer arms 11
3. Check Operations 12
4. Cleanup 12
5. Empty the Scrap Tray 12
Quick service guide 13
Troubleshooting the EAH & EC 14
➤ Will Not Start 14
➤ Out of Chemical..... 14
➤ Dishes/Glasses are Not Clean 14
➤ Machine Will Not Hold Water 14
➤ Water Running on the Floor 14
➤ Water Will Not Drain From the Machine 14
➤ Water Coming Out of the Door 14
➤ Machine Will Not Shut Off 14
➤ Machine Will Not Fill..... 15
EAH/EC Options 16
Door Handle Conversion EAH To EC #00617.30 16
Door Handle Conversion EC to EAH #00617.20..... 17

***ADDENDUM FOR MACHINES INSTALLED IN THE CITY OF CHICAGO* 18**
***ELECTRICAL DIAGRAM* 19**

	Title	Installation & Operation	Rev 1.03
	Model	EAH / EC Dishwasher	08/24/17

SPECIFICATIONS

EAH / EC Dishmachine

WATER CONSUMPTION		
PER RACK	.93 GAL.	3.53 L
PER HOUR	37 GAL.	139 L
OPERATING CYCLE		
WASH TIME-SEC	45	45
RINSE TIME-SEC	30	30
DWELL TIME-SEC	15	15
TOTAL CYCLE	90 Sec	90 Sec
OPERATING CAPACITY		
RACKS PER HOUR	40	40
WASH TANK CAPACITY	1.7 GAL.	6.44 L
PUMP CAPACITY	35 GPM	132.5 LPM
WATER REQUIREMENTS		
- Minimum	120°F	49°C
- Recommended	140°F	60°C
WATER INLET	½"	-
DRAIN CONNECTION	2"	-
CYCLE TEMPERATURES		
WASH-°F (Minimum)	120°F	49°C
FRAME DIMENSIONS		
DEPTH	25 ¾"	65.4 cm
WIDTH	25 ¾"	65.4 cm
TABLE HEIGHT	34"	86.0 cm
MAX CLEARANCE FOR DISHES	17"	43.0 cm
ELECTRICAL*	115 VAC	
	16 AMPS	
WASH PUMP MOTOR 1 HP	13.4 AMPS	
*Warning: Electrical and plumbing connections need to be made by a qualified service person who will comply with all available Federal, State and Local Health, Electrical, Plumbing and Safety codes.		
SHIPPING WEIGHT		
E (Approximate)	218#	98.7 kg
E-EXT (Approximate)	260#	117.8 kg

Note: The required flowing water pressure to the dishwasher is 15-65 PSIG. If pressures higher than 65 PSIG are present, a pressure regulating valve must be installed in the water line to the dishwasher (by others). If flowing pressure is lower than 15 psi, improper machine operation may result.

	Title	Installation & Operation	Rev 1.03
	Model	EAH / EC Dishwasher	08/24/17

GETTING STARTED

Introduction to EAH and EC

CMA low temperature upright dishwashers have been used world -wide for many years. This manual has been written to help you, the operator, in your job. Your job is one of the “most important” in this restaurant. Why? Your product, the dishes and glasses, is the first thing the customer notices when he sits down. Clean, sparkling dishes and silverware will set the mood for the customer when he observes the table setting.

Receiving and Installation

The dishwasher is shipped from the factory bubble packed on a pallet. The guidelines are listed in a step-by-step procedure for your reference.

1. Packaging

Unwrap the machine and check for the following component parts:

- Scrap accumulator complete with lid and scrap tray. This is normally an integral part of the machine
- Tube stiffeners. Tube stiffeners must be used to prevent the feed tubes from curling inside the chemical pail and sucking air. These are pre-installed to the chemical pump and attached to the back of the dishmachine. The ends of the chemical tubing have been flared so that the tubing will not pull out of the stiffener. Red is for detergent, white for sanitizer, and blue for rinse aid.

2. Electrical

Prior to installation make sure the electrical supply is compatible with the specifications on the machines data plate.

CMA standard dishwashers operate on 110 volts. Other voltage requirements are available on request.



DO NOT USE POWER CORD OR GFI OUTLET

This unit **MUST BE** hard-wired to a
dedicated appropriately size circuit breaker.

WARNING: Electrical and grounding connections must comply with the applicable portions of the National Electrical Code and/or other local electrical codes.

Note: For supply connections, use copper wire only rated at 90 degree C minimum.

WARNING: Electrical and plumbing connections need to be made by a qualified service person who will comply with all available Federal, State, and local Health, Electrical, Plumbing Safety Codes.

	Title	Installation & Operation	Rev 1.03
	Model	EAH / EC Dishwasher	08/24/17

3. Plumbing

The machine needs the following:

- 2" pipe for the drain outlet
- ½" pipe for the incoming water

➤ A flex hose or quick disconnect union. The water inlet is at the top left corner of the dishwasher

Notice to Plumber: The plumber connecting this machine is responsible for making certain that the water lines are **THOROUGHLY FLUSHED OUT BEFORE** connecting to the dishwasher

CMA recommends utilizing a water softening system to maintain water hardness measurements of 3.5 gpg (grains per gallon) or less. This will assure maximum results and optimum operation of the dishmachine.

Note: high iron levels in the water supply can cause staining and may require an iron filter. High chlorine levels in the water supply can cause pitting and may require a chloride removal system.

If an inspection of the dishwasher or booster heater reveals lime buildup after the equipment has been in service, water treatment is recommended. If water softener is already in place, ensure there is a sufficient level of salt*

4. Scrap Trap Accumulator

The scrap trap accumulator is designed to perform two basic functions:

- It allows a method to discharge all the heavy solids out of the machine with each wash and rinse cycle.
- It provides capacity to drain the contents of one cycle regardless of the ability of the existing drain to accept the discharge rate.

There is a drain connection sleeve (2") on the bottom of the scrap accumulator (See drain connection instruction).

SCRAP TRAP ACCUMULATOR CONNECTION:

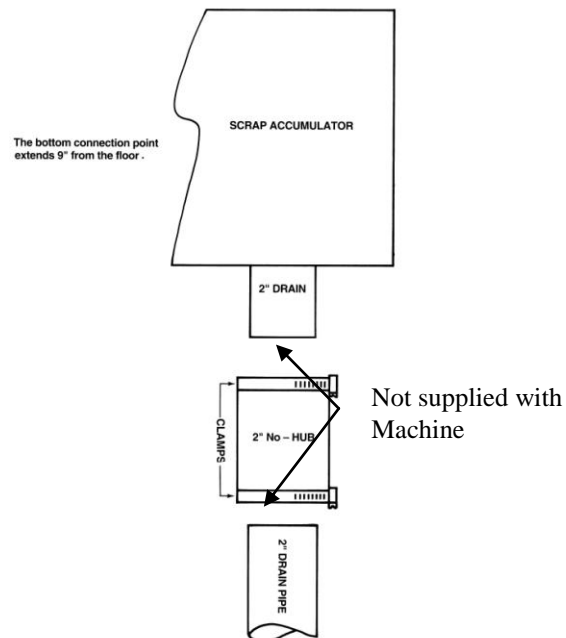

* The de-liming agents used to de-scale a commercial dishwasher, are highly caustic and de-liming must be done by a qualified chemical specialist.

	Title	Installation & Operation	Rev 1.03
	Model	EAH / EC Dishwasher	08/24/17

5. **Chemical Feeder***

The peristaltic pumps are assembled and included within the machine.

Note: Use only commercial-grade detergents and rinse aids recommended by your chemical professional. Do not use detergents and rinse aids formulated for residential dishwashers.

Low Temperatures chemical-sanitizing dishmachines must not exceed 6% sodium hypochlorite solution (bleach) as the sanitizing agent. Higher levels may damage stainless or components.

Follow the directions precisely that are on the litmus paper vial and test the water on the surface of the bottom of the glasses. Concentration should be 50 p.p.m. minimum to 100 p.p.m. maximum. If concentration is incorrect contact your chemical supplier.

6. **Activating Machine***

The machine is equipped with a prime switch to activate the peristaltic pump at any time the master switch is "ON".

Following the completion of the installation, always fill the machine with water before the machine is started.

- *Hold the fill button until the water level is approximately ½" to ¾" below the overflow hole in the PVC standpipe. This water level should be approximately even with the bottom edge splash guard in sump area of machine.*
- *Activate the prime switches for the three chemical pumps until the product is discharging into the sump.*
- *To start the machine, close the doors and the machine will cycle automatically.*

The amount of product delivered by each cam is controlled by changing the opening in each cam. When the micro switch rides down into the cam, the peristaltic pump motor begins to rotate. It will continue to rotate until it rides up out of the groove. Therefore, to extend the amount of product delivered to the machine, open the groove. To reduce the amount of product delivered to the machine, close the groove. Cams are slip fit. A cam adjustment wrench is provided, but the cam can be adjusted with a small screwdriver or the edge of a table knife.

Technical personnel are available during normal business hours should you, as an installer, have any questions. We are available to serve you at 800-854-6417.

DISCLAIMERS

CMA expressly disclaims any and all warranties, express or implied, relating to the installation of any and all CMA equipment that is installed by chemical dealers, contracted servicers or third party servicers to CMA equipment. If the installation instructions are not followed exactly (to the letter), or, if any person or company conducting the installation of the CMA equipment, revise the installation procedures or alter the instructions in any manner, the CMA warranty becomes void. If, due to the improper installation of CMA equipment, this equipment ceases to operate properly or affects other parts of the CMA dishwashing equipment, in that the other parts become defective, the CMA warranty becomes void. CMA will not be liable or responsible or warrant CMA equipment, due to improper installation of any CMA model dishwasher.

CMA does NOT endorse "Tankless On-Demand" water heaters for use on CMA Dishmachine products. On most applications, the volume of hot water required for commercial dishmachines exceeds the capacity of these types of heating sources. You will find that most, if not all, commercial dishmachines have been programmed with auto-filling features that require quick filling, with a designated limited time.

CMA DOES endorse, and highly recommends, the standard "tank" style water heaters, sized properly to handle each particular facility with their water heating requirements. A "tank" style water heater stores and supplies a large capacity of preheated water before providing hot water to the dishmachine. To meet required health codes, there must be a reliable and consistent flow of adequate hot water supplied to the dishmachine. If the facilities' "tank" style water heater is marginal in size, CMA recommends installing a proper size Hatco Booster Heater, a CMA's E-Temp 40 or 70-degree-rise Booster Heater (that can be installed on CMA Conveyors), or a CMA Temp-Sure Booster Heater (for door and undercounter dishmachines). All are designed to adequately achieve results.



WARNING! This product can expose you to chemicals which are known to the State of California to cause cancer, birth defects, or other reproductive harm. For more information visit www.P65Warnings.ca.gov

* The chemicals and water level must be programmed by a qualified chemical specialist.

	Title	Installation & Operation	Rev 1.03
	Model	EAH / EC Dishwasher	08/24/17

OPERATION

CMA dishwashers have been used worldwide for many years. This manual has been written to help you, the operator, in your job.

The manual is divided into three sections. Sections A and B cover start-up and dish handling, and section C covers troubleshooting.

Starting Instructions

- *Drain water if it is cold by lifting drain ball until all water is out of the machine.*
- *Check drain screen and clean.*
- *Replace it properly into the sump housing.*
- *Check wash arm spray tips. If clogged, clean with toothpick and rinse at sink.*
- *Check chemical lines to chemical containers*
 - A. *Red – detergent line*
 - B. *Blue – rinse agent line*
 - C. *Clear/White – sanitizer destainer line.*
- *Press fill switch; fill until water is ½" lower than overflow on drain ball shaft or to the bottom of splash shield.*
- *Hold fill switch in until water level is proper and check temperature (should be approximately 140 degrees Fahrenheit; 60 degrees Celsius).*
- *Insert tray of dishes into machine and close doors. Machine will automatically start when doors are closed.*
- *After the machine green cycle light turns off, raise doors, remove trays, and allow to dry before stacking.*
- *If the doors are lifted during a wash cycle, the machine will automatically shut off.*
- *The CMA dishmachine will complete the wash and rinse cycle and automatically feed the proper chemical and turn itself off.*

	Title	Installation & Operation	Rev 1.03
	Model	EAH / EC Dishwasher	08/24/17

Operating Instructions

1. Scraping and Pre-rinse

Remove remaining food from utensils. Scrape by hand or by using a cleaning tool such as a sponge or rubber spatula. For protection of the hands, wear gloves.

Use a pre-rinse hose for wet scraping to remove small particles of soil not removed by the hand scraping operation. The purpose is to keep excessive garbage from going into the dishwashing machine.

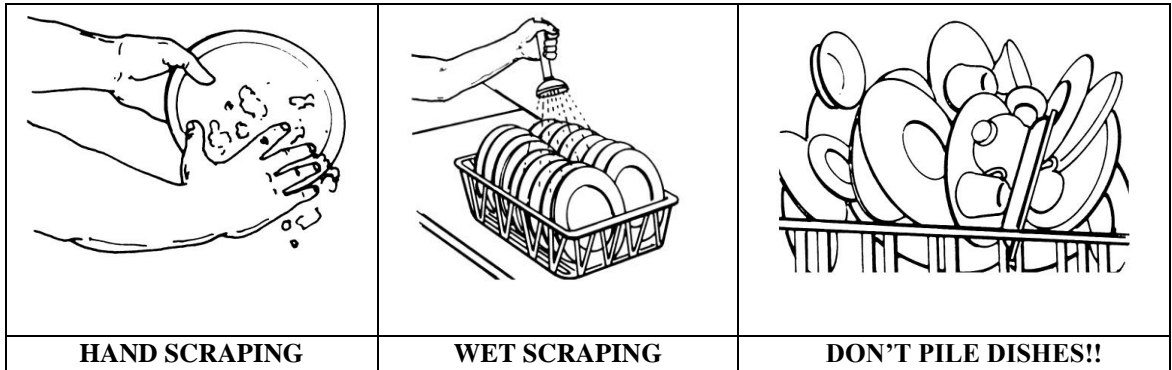

For flatware, it is recommended that they be pre-soaked in a deep pan, generally a bus pan, using a presoak detergent. This will prevent drying or adhering of soil on flatware and reduce tarnishing. A presoak detergent is especially useful for the removal of protein soil such as egg, syrup, etc. Allot approximately 30 minutes for presoaking if possible for better results.

2. Sorting and Racking

Properly placing the utensils in the rack is one of the most important jobs the operator must perform. Sort out different utensils, separating dishes, bowls, cups, glassware and flatware.

3. Racking dishes

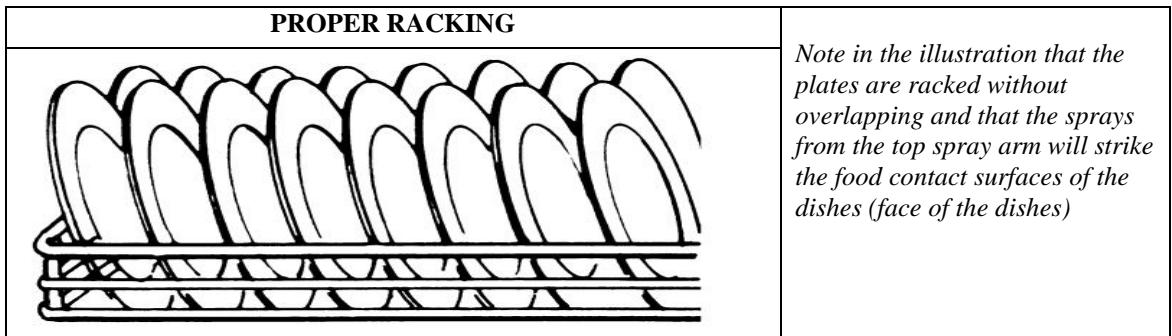

Rack all the same sized plates together row by row. The dish rack will hold them just right for proper washing. The entire surface of the soiled dish must be covered by the spray arm to provide sufficient scrubbing action when the detergent solution is being sprayed on that dish.

Stacking dishes will not save time because the dishes will not be cleaned during the wash cycle and will require sorting and rewashing.

	Title	Installation & Operation	Rev 1.03
	Model	EAH / EC Dishwasher	08/24/17

4. **Racking glasses**

Glasses, cups, bowls and other deep dishes must be racked faced down. This is so as not to carry out wash water and so the sprays can work on the internal surfaces. Rack glasses and cups in a properly sized compartmentalized glass rack. Allow to air dry.

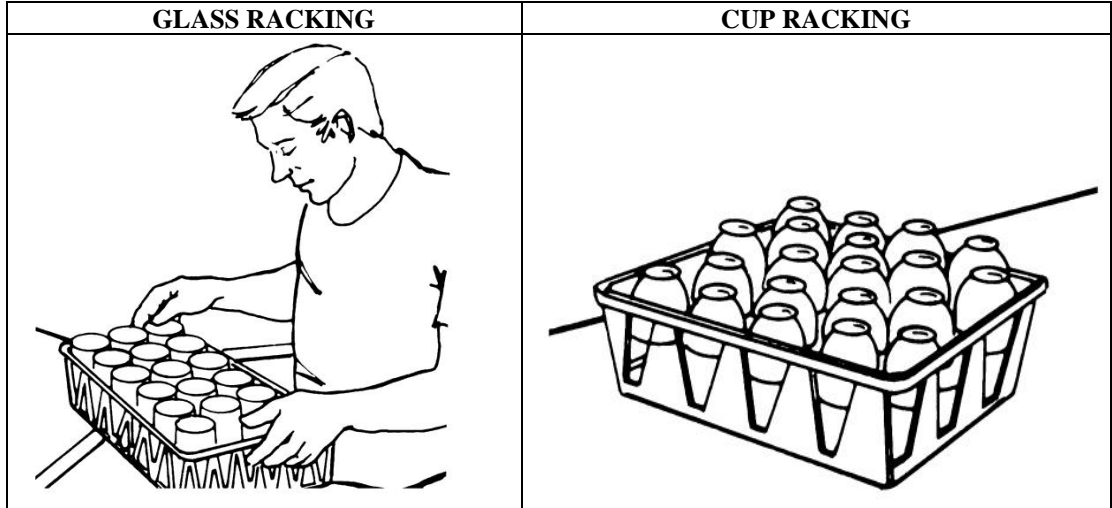

Glasses should be placed in the racks upside down in each compartment. The rinse additive is injected into the rinse water to prevent spotting and speed the drying process. (Note: A CMA representative can help you select the proper glass rack for your glasses.)

5. **Racking flatware**

After presoaking, flatware is placed in a wash basket with handles down to prevent them from “nesting” which provides maximum exposure to the wash process.

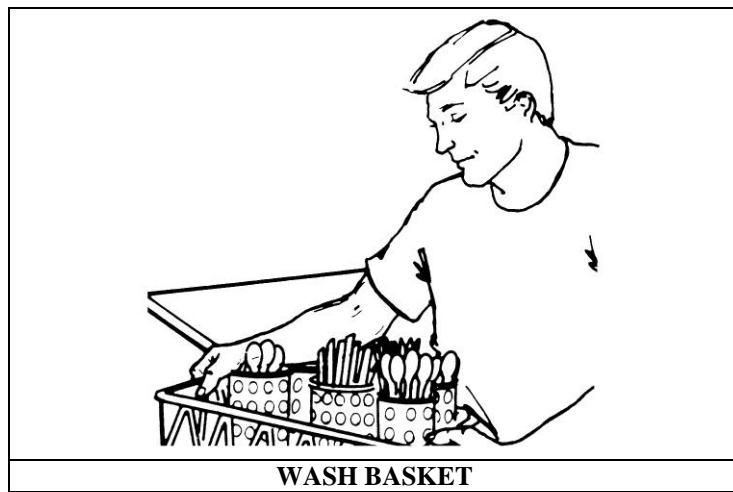

6. **Stacking & Storage**

	Title	Installation & Operation	Rev 1.03
	Model	EAH / EC Dishwasher	08/24/17

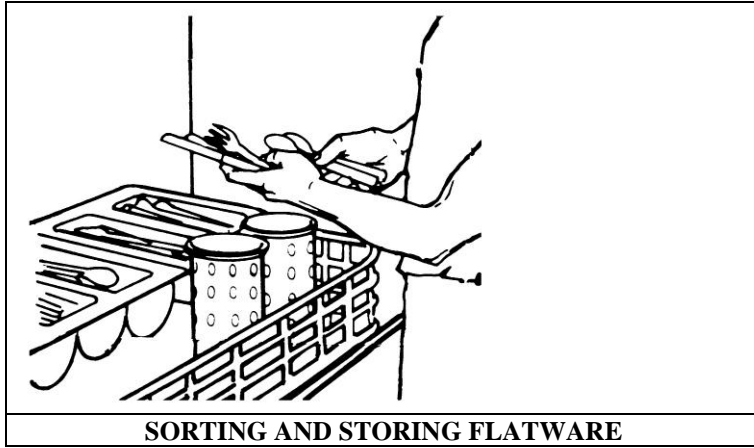

Stacking and storage of dishes being washed and sanitized is very important. A dish may be perfectly washed but be completely contaminated from the handling after washing. Avoid storing dishes where they may be soiled. Handling dishes with the hand on the food contact surfaces should be reduced to a minimum (towel drying is an incorrect procedure). Do not stack plates and dishes higher than 12 inches. Their combined weight can destroy the porcelain surface on the bottom plates.

	Title	Installation & Operation	Rev 1.03
	Model	EAH / EC Dishwasher	08/24/17

Cleaning and Maintenance

Certain times of the day should be allotted to cleaning the CMA dishwashing machine. Follow the cleaning and inspection procedures listed below:

1. Cleaning the drain screen

Remove the drain screen and thoroughly clean all foreign material from screen as shown in the illustration. **DO NOT BANG THE SCREEN ON THE TABLE TO JAR FOOD LOOSE.** Use the faucet or the pre-rinse hose. Re-install drain screen and ensure that it is in the proper position.

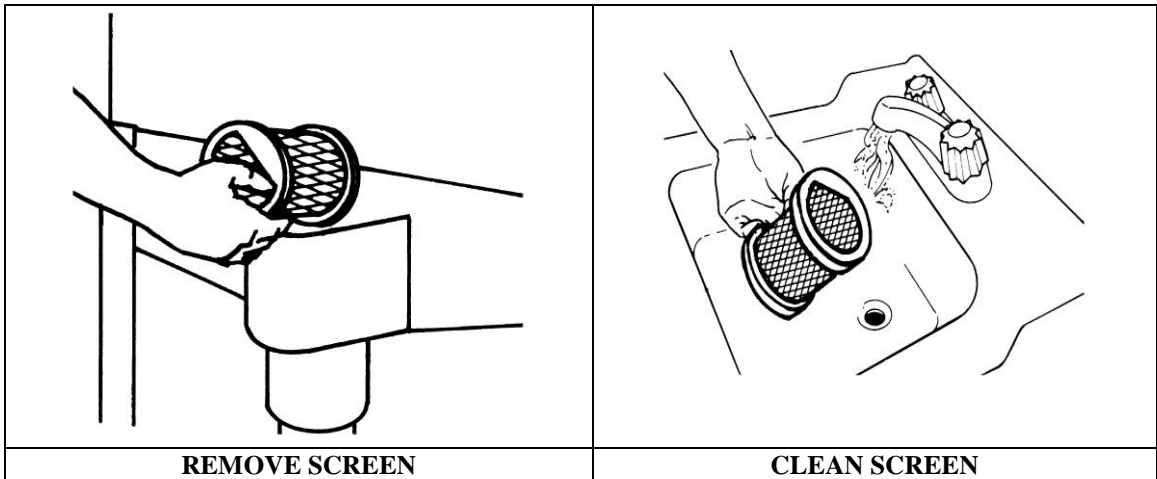

2. Cleaning the washer arms

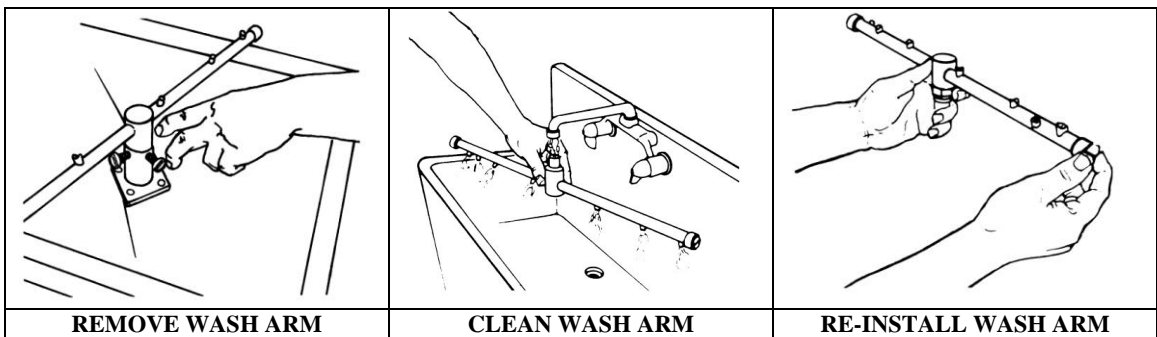

Inspect the upper and lower spray arms to ensure they are not clogged with food scraps. Otherwise, full and uniform spray pressures will not be delivered to the soiled dishes.

If there is any question as to the spray arms being clear of food scraps, the spray arms should be removed and cleaned. Note that water will blow from all jets if they are open. Use toothpick to open clogged jets and flush to ensure that food scraps are out of the arm. If necessary, the stainless plug in the end of the arm can be unscrewed and removed to clean the inside of the arm tube at the sink.

After the arm has been thoroughly cleaned, re-install back into the base.

	Title	Installation & Operation	Rev 1.03
	Model	EAH / EC Dishwasher	08/24/17

3. **Check Operations**

Operate the machine for one cycle. Watch detergent, sanitizer and rinse additive “delivery tubes” at the point where they inject chemical into the machine. Remember: red tube – detergent; blue tube-rinse; and clear white tube-sanitizer. Check temperature at the end of the cycle for 120° F minimum.

4. **Cleanup**

Wipe down the machine and check the chemical level in the containers. Also inspect machine for leaks or other items that might cause trouble during a rush period. You are now ready to wash dishes.

Remember: The chemical containers should be saved for pickup by the serviceman during his regular call. Do not throw them in the trash bin.

5. **Empty the Scrap Tray**

Remove scrap tray drawer and thoroughly rinse out. Clean tray after each meal, or once every hour if very busy.



	Title	Installation & Operation	Rev 1.03
	Model	EAH / EC Dishwasher	08/24/17

Quick service guide

TECHNICAL ISSUE	CAUSE	SOLUTION
Starts with doors open	Faulty #1 micro switch (start/stop)	Replace micro switch, P/N 00411.00
	Faulty door switch	Replace switch, P/N 00557.55
Continues cycle	Faulty #1 micro switch (start/stop)	Replace micro switch, P/N 00411.00
	Faulty start/fill switch	Replace switch, P/N 00421.40
	Faulty door switch	Replace door switch, P/N 00557.55
Wash motor will not shut off	Delimer switch in wrong position	Switch to <i>NORMAL</i> position
	Faulty motor contactor	Replace contactor, P/N 00404.82
Sanitizer pump does not run	Faulty # 6 micro switch	Replace micro switch, P/N 00411.00
	Delimer switch in wrong position	Switch to <i>NORMAL</i> position
	Faulty sanitizer pump motor	Replace sani motor, P/N 00416.00
Water solenoid leaking	Debris inside water solenoid valve	Clean and replace diaphragm, P/N 00706.00
	High water pressure on supply line	Decrease water pressure
	Faulty water solenoid valve	Replace valve, P/N 00705.00
Does not fill or hold water in tank	Leaking drain ball	Replace drain ball, P/N 00121.00
	Faulty #4 micro switch (Fill)	Replace micro switch, P/N 00411.00
	Debris inside water solenoid valve or Faulty valve	Clean and replace diaphragm/valve, P/N 00706.00, P/N 00705.00
Vacuum breaker leaks	Worn internal vac. Brkr parts	Replace or clean parts, P/N 00735.00
	Faulty check valve	Replace check valve, P/N 00715.00
	Low incoming water pressure	Increase water pressure
Only runs when start/fill switch is depressed	Faulty #1 micro switch (start/stop)	Replace micro switch, P/N 00411.00
	Faulty Door switch	Replace door switch, P/N 00557.55
Will not start/ nothing works	Wall breaker tripped	Reset breaker
	Master on/off switch on machine turned off, or faulty	Reset or replace master switch, P/N 00433.00
Runs, but none of the other functions engage	Faulty #2 Micro switch (cycle reset)	Replace micro switch, P/N 00411.00
	Faulty ice cube relay (yellow relay)	Replace relay, P/N 00631.00
	Faulty motor contactor	Replace contactor, P/N 00404.82

	Title	Installation & Operation	Rev 1.03
	Model	EAH / EC Dishwasher	08/24/17

Troubleshooting the EAH & EC

➤ **Will Not Start**

1. Check master switch on the control box to make sure that it is “ON”.
2. Check circuit breaker that services the dishwasher. Make sure it is “ON”.
3. After (ONLY after) checking steps 1 and 2, call the CMA service technicians.

➤ **Out of Chemical**

Check backup supply of chemicals. **REMEMBER!** Red product label to red tube, blue product label to blue tube, and clear/white product label to clear/white tube. Note that sometimes extra product is left in storage area at the direction of the restaurant manager. Before calling the CMA service technicians, check with the manager for backup supplies.

➤ **Dishes/Glasses are Not Clean**

1. Before you call the CMA service technician, check your temperature gauge on the machine. Check to insure water temperature is at least 120 °F. The CMA dishwasher must have hot water delivered from the primary heater at 120 ° to 140 °F. If temperature is okay, then...
2. Check that your water softener contains salt and is operating properly. Your service agreement from CMA calls for hot/soft water.
3. Check that dishes are racked properly. Check the screen and wash arm tips. If they are clear, call the CMA service technicians.

➤ **Machine Will Not Hold Water**

Check the drain actuator for a knife, spoon, fork or foreign material then remove.

➤ **Water Running on the Floor**

If water is overflowing, the scrap accumulator or the scrap drawer may need to be cleaned. If not, call your plumber- the drain may be clogged.

➤ **Water Will Not Drain From the Machine**

Check the drain solenoid. Call the CMA service technician.

➤ **Water Coming Out of the Door**

End plugs may be missing or lose. Check inside the scrap accumulator drawer. If the end plug came off during operation, it will be inside the scrap trap tray. Simply replace. If end plug is lost, call your CMA service technician.

➤ **Machine Will Not Shut Off**

You can turn off the machine in an emergency by turning off the master switch located on the back of the control box. After turning off the master switch, call the CMA service technician.

	Title	Installation & Operation	Rev 1.03
	Model	EAH / EC Dishwasher	08/24/17

➤ **Machine Will Not Fill**

Check gate valve on the top of the machine. Make sure “handle” has been opened. If it is, call your CMA service technician.

	Title	Installation & Operation	Rev 1.03
	Model	EAH / EC Dishwasher	08/24/17

EAH/EC Options

Door Handle Conversion EAH To EC #00617.30

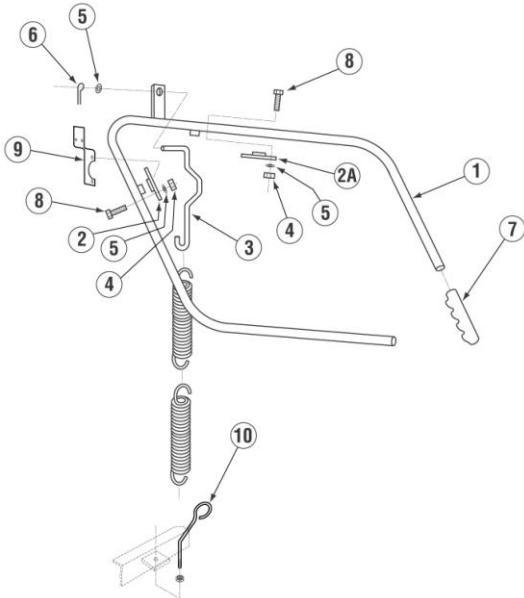

ITEM NO	NO. REQ*	P/N	DESCRIPTION
1	1	00613.04	Door Handle
2	1	00619.34	Door Hdl. Mtng. Plate-Long
2A	1	00619.44	Door Hdl. Mtng. Plate-Short
3	1	00603.04	Door Spring Extension
4	9	00913.00	5/16" - 18" Nut
5	9	00926.00	5/16" SS washer
6	1	00900.00	Cotter Pin
7	2	00607.04	Door Handle Cap 1"
8	8	00920.00	5/16"-18 x 3/4" Hex Head Bolt
9	1	00563.20	Roller Switch Bracket
10	1	00606.83	Eye Bolt
11	1	01505.04	Tray Track (c)

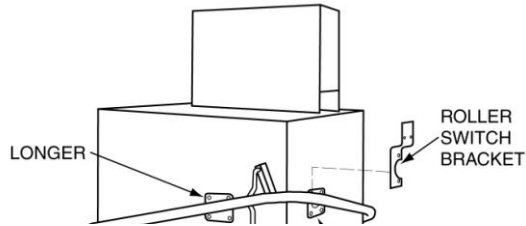

Note: Door handle mounting plates come in two sizes.
Longer is mounted on back-right side.

INSTRUCTIONS:

Before handle conversion, place template with the upper edge against two upper left front panel holes. Mark the four holes position using a center punch. Drill a 1/8" hole through each position, and then drill it out to 3/8".

1. Open dishmachine door to its highest position so that there is little spring resistance on the door handle. Remove hardware that holds the door handle to the door linkage. Save all the washers and spacers. Swing the door handle towards the back of the dishmachine and dismount it from the door handle support brackets. Remove the nut attaching the eyebolt and save the door springs.
2. Remove the two (2) door-handle support brackets on the back of the cabinet and plug the four holes with original hardware. Unscrew the 8 nuts holding the front panel and remove front panel. Remove door guides on left side of machine and mount them on the front of the cabinet. Remove tray track inline AH and replace it with the tray track (C) from the kit. Slide the left door into the door guides and mount the door linkage back on.
3. With left door facing the front, door panel on the left we are now ready to install the door handle.
4. Using provided door handle, door handle mounting plates, 5/16" bolts, nuts and washers; install the door handle as shown in "Illustrations". Match the mounting plate holes and roller switch bracket holes to the cabinet holes and insert all bolts to ensure that the door handle and mounting plates are aligned. Then secure the mounting plate and roller switch bracket with nuts and washers.
5. Attach the provided extension rod to the back of the door handle. Attach one eyebolt to the frame with existing hardware, along with two springs together. Pivot the door handle, positioning handle straight up. You may now connect loop of 2nd spring to the door extension rod. Pull handles forward and down and attach to the door links.
6. Adjust the nut on the eyebolt until the doors begin to lift then back off two turns. See "Illustration" for proper location of all door handle hardware included on EC machine.

	Title	Installation & Operation	Rev 1.03
	Model	EAH / EC Dishwasher	08/24/17

Door Handle Conversion EC to EAH #00617.20

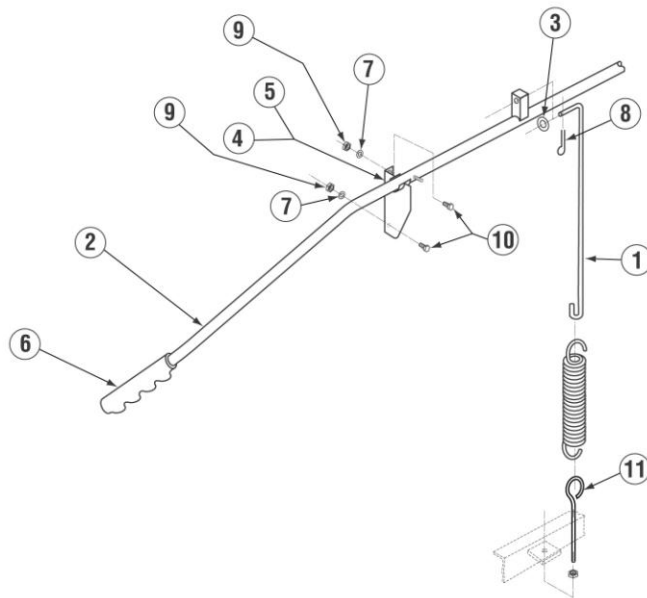

ITEM NO.	NO. REQ'D	P/N	DESCRIPTION
1	2	00603.20	Door Spring Extension Rod
2	1	00613.09	Door Handle
3	1	00926.00	5/16" SS Washer
4	1	01555.50	L.H. Door Handle Support
5	1	01556.50	R.H. Door Handle Support
6	2	00607.04	Door Handle Cap 1"
7	4	00924.00	1/4" SS Washer
8	2	00900.00	Cotter Pin
9	4	00912.00	1/4" 20 Nylon Lock Nut
10	4	00962.00	1/4"-20 x 1 SS Hex Head Bolt
11	1	00603.20	Eye Bolt
12	2	01505.32	Tray Track Inline AH

INSTRUCTIONS:

1. Open dishwasher doors to their highest position so that there is little spring resistance on the door handle. Remove hardware holding the door handle to the door linkage. Save all the washers and spacers. With the door handle in "UP" position, lift spring and remove from extension rod. Remove the nut attaching the eyebolt and save all hardware.
2. To remove the door handle, simply unscrew the four bolts holding the door handle mounting plates and slide the complete assembly up and off of the cabinet. Use the bolts, nuts and washers to plug the holes in the back of the cabinet.
3. Remove door panel & hardware from left side of machine. Remove door guides on the front of the cabinet and mount them on left side of the machine. Remove tray track (c) and replace it with the track in line from the kit.
4. Using provided nuts, bolts and washers; mount the left and right door handle supports on the back of the cabinet. Insert the eyebolt into the bracket on the frame and screw the nuts on just enough to hold them in place. Hook door spring and door spring extension rod on to the door handle and secure it with the washer and cotter pin. Then simply rest the door handle on the door handle supports. (You may have to lift the door handle to reach the handle supports.)
5. Swing the door handle downwards to reach the door linkages; and using the two provided bolts and existing washers and spacers, attach the door linkages to the door handle. Adjust the tension in the spring by tightening the nuts under the eyebolt bracket so that the doors can slide up and down freely. Mount the provided door handle grips on the ends of the door handle.
6. Eyebolt adjustment nuts should be adjusted to the point the doors begin to lift from a closed position. SEE "Illustration" for the proper location of all door handle hardware included on EAH machine.

	Title	Installation & Operation	Rev 1.03
	Model	EAH / EC Dishwasher	08/24/17

ADDENDUM FOR MACHINES INSTALLED IN THE CITY OF CHICAGO

All food dispensing establishments using chlorine or other approved chemical sanitizers shall at all times maintain an adequate testing device.

Dishes and other eating and drinking utensils to be washed in a dishwashing machine shall be properly scraped and pre-rinsed and shall be stacked in racks or trays so as to avoid overcrowding and so as to permit wash and rinse waters to reach all surfaces of each utensil.

In machine washing, multi-use eating and drinking utensils shall be washed in water containing suitable detergent at a temperature from 120 degrees F. to 140 degrees F. or other method approved by the Department of Health.

The water in the wash tank shall be changed during operation as often as necessary to keep it reasonably clean. An effective concentration of detergent in the wash water shall be maintained at all times.

Bactericidal treatment shall consist of exposure of all surfaces of dishes and utensils being washed to a rinse of clean water, at a temperature of not less than 180 degrees F. or other method approved by the Department of Health.

All dishwashing machines shall maintain a flow pressure not less than 15 or more than 25 pounds per square inch on the fresh water line at the machine and not less than 10 pounds per square inch at the rinse nozzles. A suitable gauge cock shall be provided immediately upstream from the final rinse sprays to permit checking the flow of the final rinse water. An easily readable thermometer accurate to ± 2 degrees F. shall be provided on both the wash and rinse water lines of the dishwashing machine which will indicate the temperature of the water solution therein.

Dishwashing machines shall be thoroughly cleaned at least once each day. The pumps and the wash and rinse sprays or jets shall be so designed that a forceful stream of water will reach all surfaces of the utensils when they are properly racked. These parts shall be thoroughly cleaned at least once each day. The pumps and the wash and rinse sprays or jet shall be so designed that a forceful stream of water will reach all surfaces of the utensils when they are properly racked. These parts shall be readily accessible for inspection and cleaning.

After bactericidal treatment, utensils and containers shall be stored at a sufficient height above the floor in a clean, dry place protected from flies, splash, dust, overhead leakage and condensation, and other contamination until used for serving.

Drain racks, trays and shelves shall be made of non-corrodible material and shall be kept clean.

In handling containers and utensils the surface thereof which come in contact with food or drink shall not be touched by hands, except during the process of washing.

Tables for clean and dirty dishes and food shall be so arranged that the dirty dishes will be as far removed from the food and clean dishes as may be possible.

All single-service articles and utensils shall be purchased in sanitary cartons and stored therein in a clean, dry place until used, and after removal from the cartons, these articles shall be handled in such a manner to prevent contamination.

Please note the following procedures must be followed for City of Chicago Approval:

- 1. All low energy models must have low-level sani alarms, both visual and audio.*
- 2. All models must have a City of Chicago approval data label affixed to the machine.*
- 3. Chlorine sanitizer must be a minimum of 100 PPM.*



Title

Installation & Operation

Rev 1.03

Model

EAH / EC Dishwasher

08/24/17

ELECTRICAL DIAGRAM

